



A full spectrum of sensing and signaling products for protection, detection, and safety



SWITCH PRODUCTS

SAFETY & SIGNAL MATS

SENSING EDGES

SENSING BUMPERS

SAFETY INTERFACE MODULES

LIGHT CURTAINS & LASER SCANNER

CUSTOM DESIGNS

SAFETY INTERLOCKS



Ribbon Switches

- pg 2 - 3 **Ribbon Switch Technology**
What is a ribbon switch and understanding the fail-safe concept
- pg 4 **General Purpose Ribbon Switches, 3/4 inches Wide**
Types 101 and 131
- pg 5 **General Purpose Ribbon Switches, 9/16 inches Wide**
Types 121, 141, and 151
- pg 6 **Ribbon Switches With Special Physical Properties**
Types 161 and 180
- pg 7 **Ribbon Switches With Flex Action**
Type 180
- pg 8 **Stainless Steel Ribbon Switches**
Type 191
- pg 9 **Moisture Resistant Ribbon Switches**
Types 170 and 171
- pg 10 **Chemical / Water Resistant Ribbon Switches**
Types 101-BE, 131-AE, 121-BPE, and 141-BPHE
- pg 11 **General Purpose Ribbon Switch, 5/16 inches Wide**
Type TS-3



Flex-Actuated Switches

- pg 12 **Flexswitch II**
Bend-to-operate switches
- pg 13 **Flex-Actuated Switches**
Bend-to-operate switches



NexGen™ Encased Linear Switches

- pg 14 **NexGen™ Tamper Resistant Switches**
Protected, impact resistant, tamper resistant switches with or without illumination



Touch Pads & Large-Area Switches

- pg 15 **TP-2 & TP-4 Touch Pads**
Sealed large-area switches



Panic Alarm Signaling System

- pg 16 **Panic Alarm Signaling System**
Strip switch, emergency signal system already made and do it yourself kit



Foot & Hand Switches

- pg 17 **Foot Switches, Custom Hand Switches, & Sensing Cells**
Squeeze, press, and flex designs
- pg 18 **Tactile and Non-tactile Remote Switches**
Tactile and non-tactile remote switches, single, dual dome, or press at any point



Vehicle Sensing Products

- pg 19 **RBMA Vehicle Sensing Switch**
Low-cost, weather-resistant, and durable
- pg 20 **Non-Corroding Vehicle Sensor**
Flexible housing, double-sealed
- pg 21 **Car Wash Vehicle Sensing Mat**
Molded construction, immersible



Safety Interface Module

- pg 22 **PSSR/2 Controller**
Fail-safe control unit for use with two wire conductor sensing products

WHAT ARE RIBBON SWITCHES

Ribbon switch technology and how it works



Controflex™ Ribbon Switches are normally open, momentary-contact switches for sensing, control, and other low-power applications. They are the essence of simplicity and reliable and are suited for applications ranging from general purpose switching to protection of personnel from safety hazards.

Construction consists of a bottom conductor separated by an insulating strip from an upper conductor, all in an insulated housing. They are self-bottoming, so they do not require the linkages, mountings, or interfaces of conventional sensing switches. Simple pressure completes the electrical contact. Life expectancy is millions of operations at any point.

Ribbon switches are manufactured in a continuous process which is capable of producing switches thousands of feet long. They are then cut to length and terminated, as required, to make the finished product. Many mounting options are available, including aluminum or PVC channel, self-adhesive backing and doubled-sided foam tapes.

Controflex™ Ribbon Switches are available in 2-wire standard versions for general applications and 4-wire fail-safe versions for safety applications. They are compatible with Tapeswitch Fail-Safe Interface Controllers and are UL and cUL recognized, and CE approved.

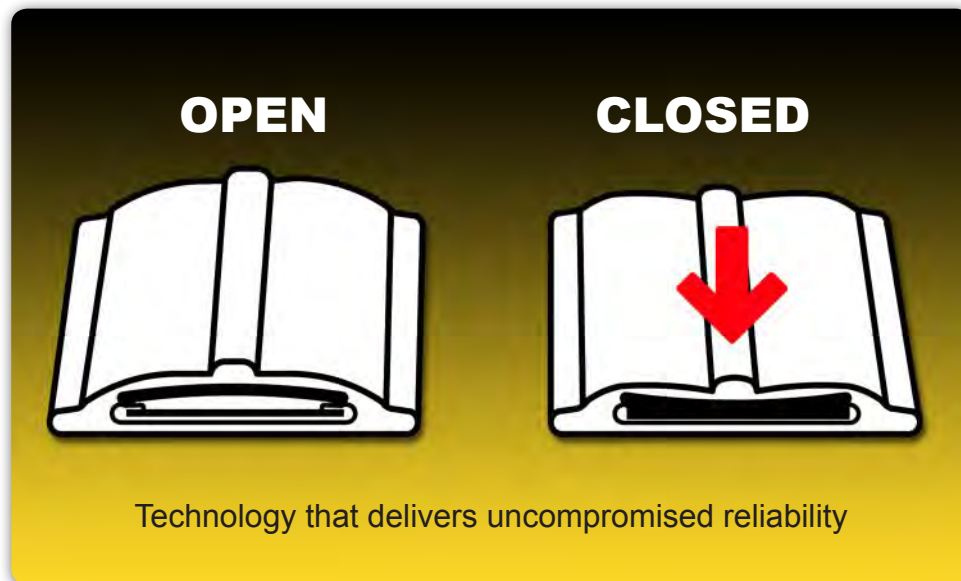

While every effort has been made to ensure the accuracy of the information provided, no liability can be taken for any errors or omission. Tapeswitch Corporation reserves the right to alter specifications and introduce improvements without prior notice.



Understanding The Fail-Safe Concept

Tapeswitch ribbon switches often provide first-line of protection for personnel and equipment. They are highly sensitive and feature press-at-any-point actuation. Properly installed and connected, they continuously monitor the protected area. However, to properly function as safety devices, switches must be installed with a fail-safe monitoring circuit as shown below or with an equivalent fail-safe methodology. Tapeswitch offers controllers that employ the fail-safe concept. Understanding and implementing the 4 conductor fail-safe concept principle of safety.

The fail-safe concept interrogates the sensor status at all times. In the event of a failure, the fail-safe concept will simulate a protected position. The “protected” position is when the sensor is activated (closed) and the “normal” or “run” position is when the sensor is not activated (open).

- Normal Conditions – constant current flow (I) holding relay coil (K1) energized
- Loss of Power – no current flow (I) and relay coil (K1) is de-energized
- Actuation of Sensor – relay coil (K1) is shorted and de-energized
- Failure of Sensor in the closed position – relay coil (K1) is shorted and de-energized
- Failure of Sensor in the open position – (broken wire, severed switch or conductor) leaves no path for current flow (I) and relay coil (K1) is de-energized
- Resistor R – limits current flow through the sensor when actuated

Fail-Safe (4 conductor)

Fail-safe is a shorthand term used to mean fail to a safe condition. In machinery with known hazards, the system is fail-safe when any failure leaves the machinery in a safe condition. The 4 conductor fail-safe concept is illustrated in the figure below. A small current is constantly flowing through the sensor at all times, holding the relay coil energized at all times. The machine control, interrupt, or stop circuitry is connected to the contacts of this relay. If the sensor is actuated, the relay coil will be shorted, causing the relay to de-energize. A resistor in series provides current limiting from overdrawing the power supply and limits the current through the sensor in the actuated position. If the sensor fails in the closed position the relay will be shorted and cannot be energized until the failure is corrected. If the sensor fails in the open position, the current path for the relay coil no longer exists and the relay coil cannot be energized until the current path is restored and the failure corrected.

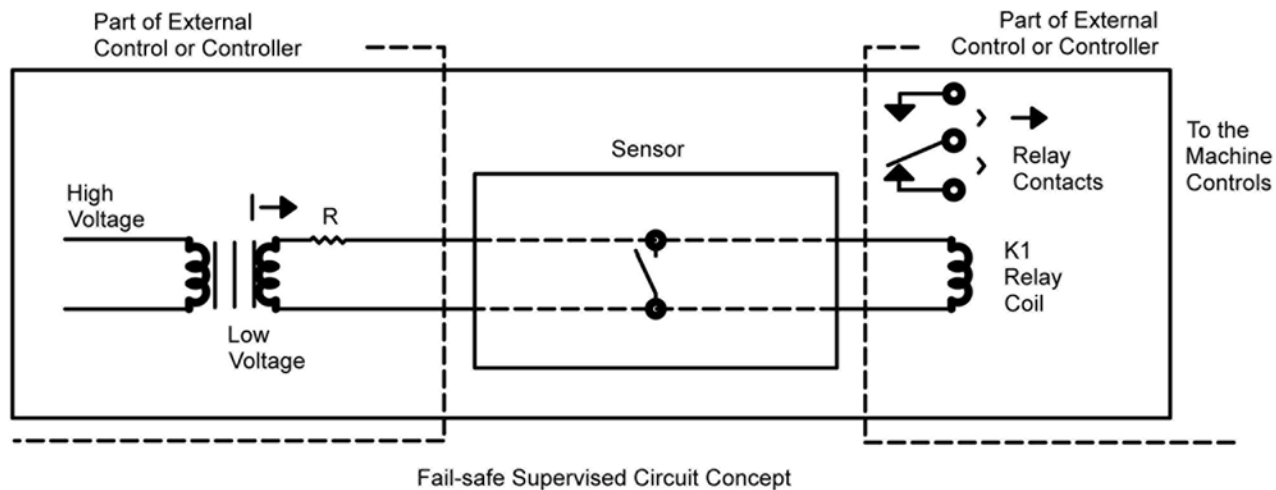

In addition to the safety aspects achieved with fail-safe, it also provides:

- Isolation of the machine controls and sensor(s)
- Isolation of high amperage and high voltage machine switching from the low voltage sensors
- Conversion of a normally open switch to required normally closed machine controls

While every effort has been made to ensure the accuracy of the information provided, no liability can be taken for any errors or omission. Tapeswitch Corporation reserves the right to alter specifications and introduce improvements without prior notice.

GENERAL PURPOSE RIBBON SWITCH, 3/4 in. WIDTH

Types 101-B, 101-BMT, 131-A & 131-AMT

This category of general purpose, pressure sensitive, ribbon switches are used for general switching and signaling. They are normally open, momentary contact switches that are actuated by pressure by hand, foot, or any mechanical device. This category of switches differs in that it has a standard width of 3/4 inch.



TYPE 101
(.180 - .200 in. High)



TYPE 131
(.180 - .200 in. High)

Mounting Options

Switch Type	Style 106 Aluminum Or PVC Channel*	DA-12 Double-Faced Tape	Screws in Block Ends
101-B	Yes	Yes	No
101-BMT	Yes	Yes	Yes
131-A	Yes	Yes	No
131-AMT	Yes	Yes	Yes

General Specifications

Activation Force*	24 oz. (7 N) for type 101 60 oz. (17 N) for type 131
Bending Radius	1 in. (25 mm) maximum for type 131 2 in. (50 mm) maximum for type 101
Exterior Covering	PVC
Color	Type 101, yellow or black Type 131, light grey
Lead Wire	#18 AWG, 18 in. (460 mm) long
Dimensions	See above
Recommended Voltage & Current	24 VAC or VDC at 1.0 amps maximum
Dielectric Resistance	1000 VAC for 2 minutes
Operating Temperature	0 to 122°F (-18 to 50°C)

Options

- Custom lead lengths
- Air leak test
- Fail-safe leads
- Adhesive backing
- Custom colors are available on request. Please contact the factory.
- Interconnected switches (sausage style)

* See notes on page 21

While every effort has been made to ensure the accuracy of the information provided, no liability can be taken for any errors or omission. Tapeswitch Corporation reserves the right to alter specifications and introduce improvements without prior notice.



GENERAL PURPOSE RIBBON SWITCH, 9/16 in. WIDTH

Types 121-BP, 141-BPH, 141-BPM, & 151-BBW

These categories of general purpose, pressure sensitive, ribbon switches are used for general switching and signaling. They are normally open, momentary contact switches that are actuated by pressure by hand, foot, or any mechanical device. The switches in this category have standard widths of 9/16 inch.



Type 141-BPH
(.265 - .285 in. High)



Type 141-BPM
(.215 - .245 in. High)



Type 121-BP
(.155 - .185 in. High)



Type 151-BBW
(.10 in. High)

Mounting Options

Switch Type	Style 104 Aluminum	DA-32 Double-Faced Tape
All	Yes	Yes

General Specifications

Activation Force*	8 oz. (2 N) except for type 141-BPH 24 oz. (7 N) for type 141-BPH
Bending Radius	1/2 in. (12 mm) maximum for types 121 & 141 1/8 in. (6.5 mm) maximum for type 151
Exterior Covering	PVC
Color	Type 141-BPH, white, red, or black Type 141-BPM, white Type 121-BP, light green or black Type 151-BBW, white
Lead Wire	#22 AWG, 18 in. (460 mm) long
Dimensions	See above
Recommended Voltage & Current	24 VAC or VDC at 1.0 amps maximum
Dielectric Resistance	1000 VAC for 2 minutes
Operating Temperature	0 to 122°F (-18 to 50°C)

Options

- Custom lead lengths
- Air leak test
- Custom colors are available on request, please contact the factory.
- Fail-safe leads
- Adhesive backing
- Interconnected switches (sausage style)

* See notes on page 21

While every effort has been made to ensure the accuracy of the information provided, no liability can be taken for any errors or omission. Tapeswitch Corporation reserves the right to alter specifications and introduce improvements without prior notice.

RIBBON SWITCHES WITH SPECIAL PHYSICAL PROPERTIES

Type 161-FS (Serpentine)

This category or type of pressure sensitive, ribbon switch has special features, model 161-FSA that has a heavy duty, protective, rubber sheath housing and is not bendable from side to side and 161-FS that is bendable from side to side up to a 30 inch radius. They are normally open, momentary switches that are actuated by pressure by hand, foot, or any mechanical device. Type 161-FS is available in a standard 9/16 inch width, while 161-FSA is available in a 1 3/4 inches width due to the protective housing.



TYPE 161-FS



TYPE 161-FSA

Mounting Options

Switch Type	DA-12 Double-Faced Tape	Floor Tile Mastic
161-FS (unshathed)	Yes	No
161-FSA (sheathed)	No	Yes

General Specifications

Activation Force*	8 oz. (2 N) unshathed 80 oz. (22 N) sheathed
Bending Radius	Do Not Bend
Exterior Covering	PVC for switch, EPDM for RBMA sheath
Color	Beige (switch) Black (RBMA sheath)
Lead Wire	#18 AWG, 6 ft. (1.8 M) long
Dimensions	9/16 in. wide, 5/32 in. high (14.3 mm x 4.0 mm) for switch 1.75 in. wide, 0.5 in. high (44.5 mm x 12.7 mm) in RBMA sheath
Recommended Voltage & Current	24 VAC or VDC at 1.0 amps maximum
Dielectric Resistance	1000 VAC for 2 minutes
Operating Temperature	0 to 122°F (-18 to 50°C)

Options

- Custom lead lengths
- Air leak test
- Fail-safe leads
- Adhesive backing
- Custom colors are available on request. Please contact the factory.
- Interconnected switches (sausage style)

* See notes on page 21

While every effort has been made to ensure the accuracy of the information provided, no liability can be taken for any errors or omission. Tapeswitch Corporation reserves the right to alter specifications and introduce improvements without prior notice.



RIBBON SWITCHES WITH SPECIAL PHYSICAL PROPERTIES

Types 180 & 180-S (Flex Action)

This category of ribbon switches, types 180 and 180-S, are flex action ribbon switches, switches with a patented snap-action property that operate when flexed at any point. Both models differ in actuation force and vary in color. Made to order custom colors are available.



TYPE 180



TYPE 180-S

Mounting Options

Switch Type	Aluminum Channel	DA-32 Double-Faced Tape
180	No	Yes
180-S	No	Yes

General Specifications

Activation Force* (10° to 15° bend to actuate)	8 oz. (2 N) for Type 180 16 oz. (4 N) for Type 180-S
Bending Radius	10 to 15° bend to actuate
Exterior Covering	PVC
Color	Type 180, red only Type 180-S, orange only
Lead Wire	#22 AWG, 18 in. (460 mm) long
Dimensions	9/16 in. wide, 5/32 in. high (14.3 mm x 4.0 mm)
Recommended Voltage & Current	24 VAC or VDC at 1.0 amps maximum
Dielectric Resistance	1000 VAC for 2 minutes
Operating Temperature	0 to 122°F (-18 to 50°C)

Options

- Custom lead lengths
- Air leak test
- Fail-safe leads
- Adhesive backing
- Custom colors are available on request. Please contact the factory.

* See notes on page 21

While every effort has been made to ensure the accuracy of the information provided, no liability can be taken for any errors or omission. Tapeswitch Corporation reserves the right to alter specifications and introduce improvements without prior notice.

SWITCHES WITH SPECIAL ENVIRONMENTAL PROPERTIES

Type 191-S (Stainless Steel)

This category of ribbon switches, Type 191-S, have stainless steel conductors. The stainless steel conductor gives this ribbon switch a non-corrosive property, which is excellent for underwater or outdoor applications, as well as indoor applications. The switch has a bending radius of 2 inches (50 mm) maximum. The exterior housing is made of PVC and is beige in color.



TYPE 191-S

Mounting Options

Switch Type	Aluminum Channel	DA-32 Double-Faced Tape
191-S	No	Yes

General Specifications

Activation Force*	12 oz. (3 N)
Bending Radius	2 in. (50 mm) maximum
Exterior Covering	PVC
Color	Beige
Lead Wire	#22 AWG, 18 in. (460 mm) long
Dimensions	9/16 in. wide, 3/16 in. high (14.3 mm x 4.8 mm)
Recommended Voltage & Current	24 VAC or VDC at 1.0 amps maximum
Dielectric Resistance	1000 VAC for 2 minutes
Operating Temperature	0 to 122°F (-18 to 50°C)

Options

- Custom lead lengths
- Air leak test
- Fail-safe leads
- Adhesive backing
- Custom colors are available on request. Please contact the factory.
- Interconnected switches (sausage style)

* See notes on page 21

While every effort has been made to ensure the accuracy of the information provided, no liability can be taken for any errors or omission. Tapeswitch Corporation reserves the right to alter specifications and introduce improvements without prior notice.



SWITCHES WITH SPECIAL ENVIRONMENTAL PROPERTIES

Types 170-IS & 171-IS (Moisture Resistant)

This category of ribbon switches, type 170-S are moisture resistant. The 171-S does not have an inline moisture trap, while model 171-IS has an inline moisture trap. Both models use a dri-run cable with no fibrous fillers which eliminates wicking. The rubber sheath housing increases the durability of the switch. Both these models have a high 160 oz. actuation force.



TYPE 170-IS



TYPE 171-IS

Mounting Options

Switch Type	Fastened with Duct Tape	RBMA Sheathing
170-IS	Yes	Yes
171-IS	Yes	Yes

General Specifications

Activation Force*	160 oz. (44 N)
Bending Radius	2 in. (50 mm) maximum
Exterior Covering	PVC
Color	Black
Lead Wire	#18 AWG, to #22 AWG solid, 10 ft. (3 M) long
Dimensions	5/8 in. wide, 3/16 in. high (15.9 mm x 4.8 mm)
Recommended Voltage & Current	24 VAC or VDC at 1.0 amps maximum
Dielectric Resistance	1000 VAC for 2 minutes
Operating Temperature	0 to 122°F (-18 to 50°C)

Options

- Custom lead lengths
- Air leak test
- Fail-safe leads
- Adhesive backing
- Custom colors are available on request. Please contact the factory.

* See notes on page 21

While every effort has been made to ensure the accuracy of the information provided, no liability can be taken for any errors or omission. Tapeswitch Corporation reserves the right to alter specifications and introduce improvements without prior notice.

CHEMICAL / WATER RESISTANT RIBBON SWITCHES

Types 101-BE, 131-AE, 121-BPE, & 141-BPHE

These types of general purpose ribbon switch have special chemical and water resistant properties. They can be activated by hand, foot, or mechanical device. It is available with sleeve ends or block ends, which have mounting holes. Length is cut to customer requirements.

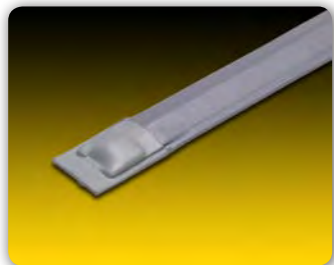

Type 101-BE
(.180 - .200 in. High)

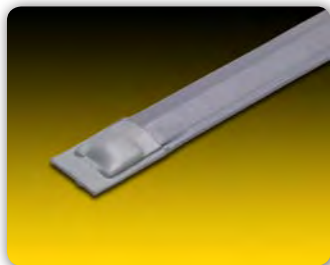

Type 131-AE
(.180 - .200 in. High)

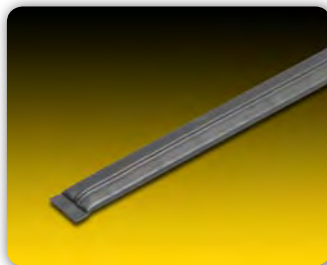

Type 121-BPE
(.155 - .185 in. High)



Type 141-BPHE
(.265 - .285 in. High)

Mounting Options

Switch Type	Channel Type	Double Face Tape
101-BE	106 Aluminum or PVC	DA-12
131-AE	106 Aluminum or PVC	DA-12
121-BPE	104 Aluminum	DA-32
141-BPHE	104 Aluminum	DA-32

General Specifications

Activation Force*	24 oz. (7 N) for Type 101 60 oz. (17 N) for Type 131	8 oz. (2 N) for Type 121 24 oz. (7 N) for Type 141
Bending Radius	1 in. (25 mm) maximum for Type 131 2 in. (50 mm) maximum for Type 101	.5 in (12 mm) maximum for Type 121 & 141
Exterior Covering	Rubber	
Color	Grey	
Lead Wire	#18 AWG (101, 131), #22 AWG (121, 141) 18 in. (460 mm) long	
Dimensions	3/4 in. wide, Type 101-BE & 131-AE 9/16 in. wide, Type 121-BPE & 141-BPHE	
Recommended Voltage & Current	24 VAC or VDC at 1.0 amps maximum	
Dielectric Resistance	1000 VAC for 2 minutes	
Operating Temperature	0 to 122°F (-18 to 50°C)	

Options

- Custom lead lengths
- Air leak test
- Fail-safe leads
- Adhesive backing
- Interconnected switches (sausage style)

* See notes on page 21

While every effort has been made to ensure the accuracy of the information provided, no liability can be taken for any errors or omission. Tapeswitch Corporation reserves the right to alter specifications and introduce improvements without prior notice.



GENERAL PURPOSE RIBBON SWITCH, 5/16 in. WIDTH

Type TS-3 High Profile

The TS-3 general purpose ribbon switch is unique being the highest profile and largest surface area ribbon switch available at 5/16 of an inch high and 1/2 inch wide. The TS-3 offers millions of actuations at any point with immediate actuation from front or side. It can be manufactured according to customer requirements in lengths from 6 inches up to 100 feet long. Typical applications include, but are not limited to pressure sensitive detection, signaling, and emergency stops on long assembly lines or conveyor systems, automatic door sensing, foot switches, or anywhere a pressure sensitive switch is needed to ensure detection.



TYPE TS-3

Mounting Options

Switch Type	Aluminum Channel	DA-32 Double-Faced Tape
TS-3	Yes	Yes

General Specifications

Activation Force*	3.0 lbs. (13 N) nominal (no channel) 4.0 lbs. (18 N) nominal (in channel)
Overtravel	None
Exterior Covering	PVC
Color	Black, Red, & White
Lead Wire	#22 AWG, 18 in. (460 mm) long
Dimensions	5/16 in. wide, 1/2 in. high (8 mm x 12 mm)
Recommended Voltage & Current	24 VAC or VDC at 1.0 amps maximum
Dielectric Resistance	1000 VAC for 2 minutes
Operating Temperature	0 to 122°F (-18 to 50°C)

Options

- Custom lead lengths
- Air leak test
- Fail-safe leads
- Adhesive backing
- Custom colors are available on request. Please contact the factory.
- Interconnected switches (sausage style)

* See notes on page 21

While every effort has been made to ensure the accuracy of the information provided, no liability can be taken for any errors or omission. Tapeswitch Corporation reserves the right to alter specifications and introduce improvements without prior notice.

Flexswitch II

Flexswitch II is a flexible switch is used as a lever, limit, paddle or wand switch. It has a 4 oz. (1.1 N) actuation force at ¼ inch (6.4 mm) from the tip with millions of actuations at any point. It has an actuating angle of $10^{\circ} \pm 5^{\circ}$ (contacts open beyond a 15° bend). Easy installation with mounting bracket. Tolerant of off angles.

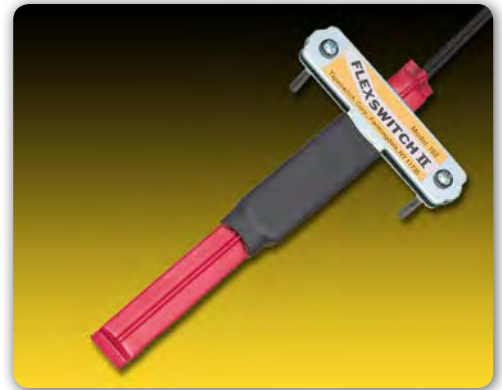

Features & Benefits

- Simpler and more reliable than conventional switches
- Cannot break if over-pushed, unlike paddle or lever switches
- Simple, flexible mounting, adjusts easily to optimize operation
- Tolerant of off-angle hits
- Switch life in excess of millions of operations

Applications

- Limit switch for controlling conveyors
- Paddle switch for counting products
- Wand switch for machine process control
- Limit switch for machine tools
- Wand switch for positioning loads
- Paddle switch for use in ADA applications
- Paddle switch for laser surgery power
- Wand switch for a cut-to-length line

General Specifications

Active Switch Length	2-1/4 in. (76 mm)
Actuation Force	4 oz. (1.1 N) at 1/4 in (6.4 mm) from tip
Actuation Angle	$10^{\circ} \pm 5^{\circ}$ (contacts open beyond 15° bend)
Recommended Voltage & Current	24 VAC or VDC at 1.0 amps maximum
Operating Temperature	0 to 122°F (-18 to 50°C)
Exterior Shell	Red PVC
Design Life	Millions of actuations

While every effort has been made to ensure the accuracy of the information provided, no liability can be taken for any errors or omission. Tapeswitch Corporation reserves the right to alter specifications and introduce improvements without prior notice.



Flex Actuators

A smaller version of the Flexswitch II! There are three different models available that differ in material composition, stainless steel, PVC and aluminum for different environments. It is IP67 rated. The housing has a standard 1/2 inch non-tapered pipe threads and the models include a universal mounting bracket, which allows for easy mounting.



Features & Benefits

- Three different body types
- Tough and durable
- Easy installation
- Flexible mounting configuration
- Mates to standard threads
- Universal mounting bracket included

Applications

- End travel limit switch
- Position indicator
- Counting signal
- Load indicator
- Stop switch
- Over travel indicator
- Home stop limit switch
- Door or hatch closure detection

General Specifications

Active Switch Length	3 in. (76 mm)
Actuation Force	4 oz. (1.1 N) at 1/4 in. (6.4 mm) from tip
Actuation Angle	10° ± 5° (contacts open beyond 15° bend)
Recommended Voltage & Current	24 VAC or VDC at 1.0 amps maximum
Operating Temperature	0 to 122°F (-18 to 50°C)
Exterior Shell	Black PVC
Design Life	Millions of actuations

While every effort has been made to ensure the accuracy of the information provided, no liability can be taken for any errors or omission. Tapeswitch Corporation reserves the right to alter specifications and introduce improvements without prior notice.

NEXGEN™

The NexGen™ is a momentary contact switch enclosed in a vandal resistant Lexan housing which protects the switch and visible instructions. It has an actuation force of 5 lbs., fail-safe, and a design life of millions of actuations at any point. It is available in standard lengths up to 72 inches. Color, text and graphics can be added to the window of the housing to provide a visible display or instruction of “press to open” or any group of words. Simple mounting options ensures ease of installation, The enclosed switch is used in many applications in many industries.



Features & Benefits

Clear, impact-resistant cover to:

- Survive rough or abusive use
- Resist vandalism or tampering
- Protect internal labels

Custom color, graphics, and labels to:

- Match equipment or area color schemes
- Provide operating instructions
- Meets requirements for ADA applications

Applications

- Passenger signaling
- Door operation for physically challenged
- Handicapped call switch
- Podium or stage signaling
- Machine stop switch
- Assembly line shutdown
- Movable shelving or partition operation
- Marine switch applications

General Specifications

Activation Force*	5 lbs. (22 N) nominal
Recommended Voltage & Current	24 VAC or VDC at 1.0 amps maximum
Operating Temperature	0 to 122°F (-18 to 50°C)
Design Life	Millions of actuations
Options	Colored inserts, graphic, or text

* See notes on page 21

Illuminated Signal Switch (NexGen)

The addition of LEDs make this product excellent for applications, where visibility is an issue. The extra lighting offers increased visibility for night applications or dimly lit areas. These vandal resistant illuminated switches can be used in many industries and typical applications include public transportation, manufacturing e-stops, and door openers.

While every effort has been made to ensure the accuracy of the information provided, no liability can be taken for any errors or omission. Tapeswitch Corporation reserves the right to alter specifications and introduce improvements without prior notice.



TOUCHPADS & LARGE AREA SWITCHES

TP-2 & TP-4 Touchpads

The TP Touch pads are momentary contact switches. The touch pads have an actuation force of 5 pounds, are fail-safe, and are capable of millions of actuations at any point. They are available in 2 x 2 or 4 x 4 inch squares. They are water resistant. A frame or adhesive mounting option makes for an easy installation. Custom colors available for large orders. Custom ordering includes text, graphics, and logos. They can be used for any application where a switch is required, including but not limited to machine operation and machine stop switch in manufacturing, wall mounted door switch in any industry, and handicap access control in mass transit,

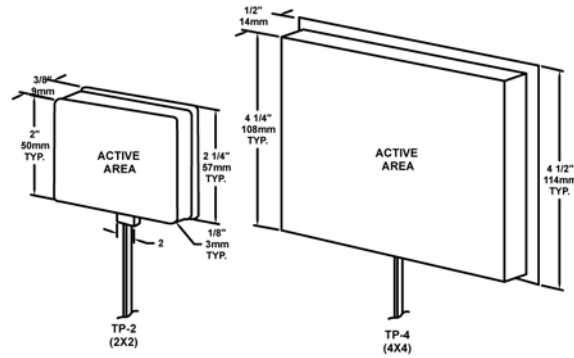
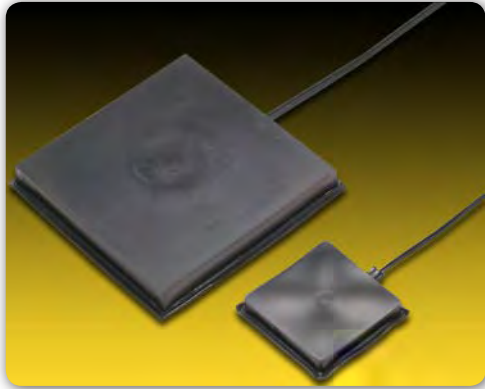

Features & Benefits

- Large active area of 4 or 16 square inches
- Tolerate high pressure washdowns
- Rated for outdoor applications
- Sensitive 5 pounds activation force
- Long life, millions of operations
- Custom colors, graphics, text, and logos

Applications

- Machine operation
- Machine stop switch
- Wall mounted door switch
- Physically challenged access control
- Any application requiring a large switch

General Specifications

Actuation Force	5 lbs. (22 N) nominal (custom actuation force available)
Exterior Housing	PVC
Standard Sizes	2 in. x 2 in. (51 mm x 51 mm) 4 in. x 4 in. (102 mm x 102 mm)
Recommended Voltage & Current	24 VDC at 1.0 amps maximum
Environment	Watertight, 0 to 122°F (-18 to 50°C)
Colors	Black (custom colors available)

While every effort has been made to ensure the accuracy of the information provided, no liability can be taken for any errors or omission. Tapeswitch Corporation reserves the right to alter specifications and introduce improvements without prior notice.

Panic Alarm Signaling System and Illuminated Panic Alarm Signaling System



The Panic Alarm Signaling Switch is a switch-strip that can easily be operated by a hand, finger or arm. It can be operated over its entire length and so it is ideal for installation in hospitals, care homes, interview or consulting rooms, in fact anywhere where people may need to signal for help or assistance. The PASS is designed to be mounted along the wall of a room or even along the length of a corridor and can be configured to suit the shape of any room.

It can be used to act as a emergency-call system to summon assistance when personnel are under threat in high risk situations, such as Medical Consulting Rooms, Prison or Police

Station Interview Rooms, Government Offices etc. Equally it can be used to request emergency help such as in Hospitals, Disabled Toilets or Residential Care Homes.

The PASS has been developed from the Tapeswitch's highly successful ribbon-switch technology which has been used in industry for many years. The PASS consists of a Tapeswitch ribbon switch fitted behind a brightly-colored anti-tamper cover. The PASS is very simple, durable, reliable, tamper-proof and difficult to vandalize. Its construction makes it ideal for situations where the customer needs to have the confidence that the system can be relied upon, even in the toughest of applications. Also available in a do-it-yourself kit.

Features and Benefits

- Color option
- Operates over entire length
- Optional activation capabilities
- Tamper-proof
- Illumination options available
- End cap options available
- Easy installation
- Robust and reliable
- Fits into standard trunking
- Do it yourself kits available

Applications

- Hospitals
- Residential care homes
- Disability assistance
- Emergency vehicles
- Any public or commercial facility
- Police stations

General Specifications

Activation Force*	Custom call factory
Recommended Voltage & Current	Switch 24 VAC or VDC at 1.0 amps maximum LEDs 12 VDC as standard (No. of LEDs x 5 mA)
Operating Temperature	0 to 122°F (-18 to 50°C)
Dimensions	44 mm wide x 16 mm high
Switch Color	Gray/red stripe, or blue
End-cap Color	Black, or white
Design Life	Millions of actuations

* See notes on page 21

While every effort has been made to ensure the accuracy of the information provided, no liability can be taken for any errors or omission. Tapeswitch Corporation reserves the right to alter specifications and introduce improvements without prior notice.



FOOT, HAND, AND SENSING CELL SWITCHES

Foot & Hand Switches

Models 111 & 111-B Foot Switches

Model 111 foot switches are normally-open, momentary-contact switches. They are also suitable for use as hand switches which can be pressed or squeezed to operate. These switches utilize ribbon switch technology, which ensures long life and reliable operation.



General Specifications

Material	PVC
Dimensions	2 in. x 5 in. (51 mm x 127 mm) 0.0375 in. (9.5 mm) thick
Switch Rating	100 watts
Operating Force	5 lbs. foot pressure (Model 111) 1.5 lbs. foot pressure (Model 111-B)



Custom Foot & Hand Switches

Tapeswitch can design and manufacture custom foot or hand switches to your specifications. Some examples are shown to the right. For information or help with your application, contact us.



ADA Handicap Switch



PASS Switch

Sensing Cell Switches

Models NO-1 & NO-1R Normally Open Sensing Cells

These are low-profile, sealed sensing switches in wafer form. They are surface-mounted and are typically used under objects to detect removal. They can also be used as limit switches in tight quarters. Positive bottoming withstands substantial weight.



General Specifications

Material	PVC
Dimensions	1.5 in. (38 mm) diameter NO-1 1 in. x .75 in. (25 mm x 19 mm) NO-1R
Operating Force	2.5 lbs. (11N) nominal
Mounting	Mastic cement, epoxy, DA-12 tape or optional metal holder



Custom sizes and shapes can be manufactured to suit your individual application requirements. **Contact our Customer Service/Technical Sales Support Department** for help in selecting the correct product for your specific application at **1-800-234-8273** or Contact Us via e-mail at **sales@tapeswitch.com**.

While every effort has been made to ensure the accuracy of the information provided, no liability can be taken for any errors or omission. Tapeswitch Corporation reserves the right to alter specifications and introduce improvements without prior notice.

Tactile and Non-Tactile Remote Switches

These smaller, press to activate switches are used to start an operation with minimal pressure. We offer three different standard remote switches that differ in actuation points, including a single dome tactile remote switch, a dual dome tactile remote switch, and a press at any point non-tactile remote switch, but custom manufacturing is also available. Typical usage of the single dome tactile remote switch includes operation or activation of lights, lasers and scopes. They have extremely low actuation forces and offer millions of actuations at any point. They are available in custom sizes and lengths to meet individual application requirements.

Tactical Remote Switch (Non-Tactile)



Material	Polyurethane
Operating Force	0.6 lbs. (9 - 10 oz.) with a 4.5 mm sphere
Recommended Voltage & Current	24 VAC or VDC at 1.0 amps maximum
Lead Wire	#22 AWG 2 conductor
Dimensions	3 in. x 7/8 in. wide Custom sizes available call factory

Single Dome Tactile Remote Switch



Material	Urethane
Operating Force	1.5 lbs. (24 - 25 oz.) with a 4.5 mm sphere
Recommended Voltage & Current	24 VAC or VDC at 1.0 amps maximum
Lead Wire	#24 AWG 2 conductor
Dimensions	3 in. x 7/8 in. wide Custom sizes available call factory

Dual Dome Tactile Remote Switch



Material	Urethane
Operating Force	1 - 1.2 lbs. (16 - 19 oz.) with a 4.5 mm sphere
Recommended Voltage & Current	24 VAC or VDC at 1.0 amps maximum
Lead Wire	#24 AWG 3 conductor
Dimensions	3 in. x 7/8 in. wide Custom sizes available call factory

While every effort has been made to ensure the accuracy of the information provided, no liability can be taken for any errors or omission. Tapeswitch Corporation reserves the right to alter specifications and introduce improvements without prior notice.



RBMA & RB-S Vehicle Sensing Switch

The RBMA & RB-S vehicle sensing, road switches are a normally open, momentary contact switches. They are capable of millions of actuations at any point. It can be an excellent replacement for expensive “induction loop” sensors. They are weather resistant. A unique feature of the RBMA model is the steel mounting channel with a bracket, which can be mounted with studs, nails, or cement, making mounting possible even on asphalt and concrete. The RB-S can be attached to a road’s surface mechanically or by using an adhesive. The vehicle sensing switches should be ordered long enough, so that there is minimal traffic travel over the ends. The C-178 end protector for applications, where traffic can not be kept off the ends of the switch.



Features & Benefits

- Replaceable switch assemblies for easy maintenance
- Double-sealed for durability and reliability
- Solid core leads to prevent wicking
- Switch life in excess of 3 million operations
- Versatile mounting on concrete or asphalt

General Specifications

Actuation Force	20 lbs. (90 N) nominal
Recommended Voltage & Current	24 VAC or VDC at 1.0 amps maximum
Cross-section	2 in. (51 mm) wide, 7/16 in. (11 mm) high
Standard Lengths	2 ft., 3 ft., 5 ft., 8 ft., 10 ft. (0.6 M, 0.9 M, 1.5 M, 3.0 M)
Replacement Switch Insert	Type 171-IS ribbon switch

Type RB-S Road Switch

RB-S Road Switch features the same design and functional versatility as RBMA road switch, except the steel mounting channel is omitted. RB-S switch may be attached to the road surface mechanically or using an adhesive.

Road switches should be ordered long enough so that traffic travel over the ends of the switch is minimized. Use the C-178 End Protector for those applications in which traffic cannot be kept off the ends of the switch.

While every effort has been made to ensure the accuracy of the information provided, no liability can be taken for any errors or omission. Tapeswitch Corporation reserves the right to alter specifications and introduce improvements without prior notice.

Non-Corroding Vehicle Sensing Switch

The non-corroding vehicle sensing switch is waterproof and ideal for weathered environments, or application where the switch will come in contact with water or wet conditions. They are IP67 rated. It provides contact closure when depressed at any point. When mounted on a floor, it can perform as a vehicle counting and detection device. When mounted on a wall or dock, it can signal when actuated. The flexible housing allows for fit on contoured and irregular surfaces.



Features & Benefits

- Rugged and corrosion-proof for long life
- Flexible housing mounts on irregular surfaces
- Double-sealed for weather-resistance and high reliability
- Available in lengths from 1 to 16 feet (0.3 to 4.9 meters)
- Fail-safe wiring available to ensure circuit integrity

Applications

- Vehicle/axle sensing or counting
- Contact detection on docking ramps
- Floor-mounted emergency stop sensors
- Vehicle positioning in service centers
- Entry control and intrusion detection
- Car wash signaling and control

General Specifications

Actuation Force	20 lbs. (90 N) nominal
Recommended Voltage & Current	24 VAC or VDC at 1.0 amps maximum
Environment	IP67 rated
Material	Extruded PVC, UV stabilized
Available Sizes	Custom sizes from 1 to 16 ft. (0.3 to 4.9 M)
Colors	Black with yellow

While every effort has been made to ensure the accuracy of the information provided, no liability can be taken for any errors or omission. Tapeswitch Corporation reserves the right to alter specifications and introduce improvements without prior notice.



Car Wash Vehicle Sensing Mat

The Car Wash Vehicle Sensing Switch senses downward and irregular pressures. It is waterproof and can be used in harsh vehicle wash down systems, molded from 100% PVC Plastisol. They feature anti-wicking Dri-run cable which provides the lead wires with added protection from moisture. We carry standard sizes in stock. We custom manufacture with customizable options that include special sizes, shapes, cut-outs and the additions of multiple sensing zones to fit application requirements. Tapeswitch Corporation has the shortest lead times in the industry.



Features & Benefits

- Heavy duty steel base plate provides solid mounting points
- Edge options allow a choice of recessed or surface mounting
- Dri-Run cabling prevents moisture wicking through the lead wires
- Completely immersible, IP67 rated mat ensures a long operating life

General Specifications

Actuation Force	15 lbs. (67 N) nominal
Recommended Voltage & Current	24 VAC or VDC at 1.0 amps maximum
Environment	IP67 rated, 0 to 122°F (-18 to 50°C)
Material	Molded PVC
Lead Wires	18/2 AWG Dri-Run Cable
Colors	Gray or Yellow
Mounting	3/16 in. (4.8 mm) holes (4) in steel base plate

About Activation Force Ratings

1. All operating force ratings are nominal, based on force applied with 4.5 mm diameter sphere. Total operating force increases with increases in contact area.
2. Ribbon switches sense force up to 30 degrees from the perpendicular.
3. Operating force requirements increase at low temperatures (below rating)

While every effort has been made to ensure the accuracy of the information provided, no liability can be taken for any errors or omission. Tapeswitch Corporation reserves the right to alter specifications and introduce improvements without prior notice.

PSSR/2 Control Unit

The PSSR/2 control unit is designed to be used in conjunction with Tapeswitch Corporation pressure sensitive sensor products to make a complete safety system. Sensors may take the form of safety mats, sensing edges, or ribbon switches but must incorporate an internal 6.8 K Ω or 8.2 K Ω end of the line resistor.

When the PSSR/2 is used with suitable Tapeswitch sensing edges, bumpers, switches or mats the system meets the requirements of EN13849-1:2006 PLd, EN62061 SIL2 and is a Category 3 configuration. It is an extremely compact unit which has a 22.5 mm DIN rail enclosure ideal for mounting in control panels. The PSSR/2 has a manual or auto reset function and operates from 24 VDC.



Features & Benefits

- Works with all mats, edges, and switches
- Category 3 PLd SIL2
- End of line resistor monitoring
- DIN rail mounted
- 24 VDC supply voltage
- Manual or auto reset
- Self-monitoring
- 3 Output contacts

General Specifications

Safety Performance Level	Category 3, PLd (EN13849-1:2008)	
Probability of dangerous failures per hour (PFHd)	1.03 x 10 ⁻⁷	
Power Consumption	< 5 VA	
Response Time	13 ms	
Temperature Range	14 to 131°F (-10 to 55°C)	
Reset Function	Auto or Manual	
Supply Voltage	24 VAC or VDC	
Safety Outputs	Device Type	Safety relay, Force guided relays
	Contacts	2 x N/O, 1 x N/C
	Rating	(monitor) 5 A @ 240 VAC
Maximum Sensor Length	100 M (330 ft.)	
Enclosure Protection Rating	IP20	
Dimensions	3.31 in. high x 4.68 in. high x .88 in. wide	

While every effort has been made to ensure the accuracy of the information provided, no liability can be taken for any errors or omission. Tapeswitch Corporation reserves the right to alter specifications and introduce improvements without prior notice.



Some of the industries we serve.

Industrial Plant Maintenance Stamping Lock out **Area Guarding**

Metalworking **Plant Safety Military** Material Handling Signaling

Fabricating Manufacturing **Robotics** Process Control **OEM's**

Packaging Aerospace Public Safety Gaming **Sensing** Medical

Machine Guarding Monitoring Entertainment Access Control

Emergency Response **Transportation** Amusement Parks

Motion Sensing Monitoring Counting **Machine Control** Security



800-234-8273

Tapeswitch Corporation

100 Schmitt Boulevard, Farmingdale, NY 11735

www.tapeswitch.com • sales@tapeswitch.com

Tel: 631.630.0442 • Fax: 631.630.0454

