



A full spectrum of sensing and signaling products for protection, detection, and safety



**SWITCH PRODUCTS**

**SAFETY & SIGNAL MATS**

**SENSING EDGES**

**SENSING BUMPERS**

**SAFETY INTERFACE MODULES**

**LIGHT CURTAINS**

**CUSTOM DESIGNS**

**SAFETY INTERLOCKS**

## Pressure-Sensitive Sensing Bumpers

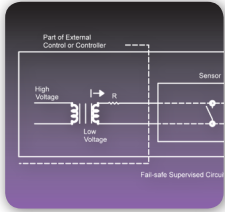

- pg. 2 **Using Bumpers in Safety Applications**  
Understanding the fail-safe concept

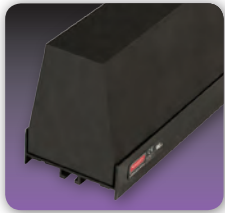

- pg. 3 **SE-45 & SE-75 Sensing Bumpers**  
For general purpose, heavy duty applications  
Width available in 4 inches and 7 inches, up to 5-3/8 inches high and 12 feet long

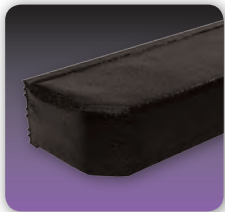

- pg. 4 **Hercules Ruggedized Sensing Bumper**  
For hostile environments that are off-limits to conventional bumpers  
Encapsulated in a rugged polyurethane shell



- pg. 5 **VBL-Series High-Impact Sensing Bumpers**  
For applications where a bumper is subject to high impacts  
Very low activation force of 4 pounds

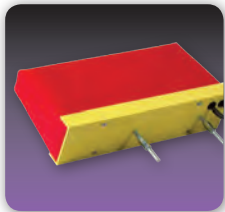

- pg. 6 **Custom Sensing Bumpers**  
Designed to fit specific application needs  
Available in various sensitivities, profiles, colors, and lengths

## Interface Controllers



- pg. 7 **Compatible Safety Interface Modules for Safety Applications**

While every effort has been made to ensure the accuracy of the information provided, no liability can be taken for any errors or omission. Tapeswitch Corporation reserves the right to alter specifications and introduce improvements without prior notice.



# USING BUMPERS IN SAFETY APPLICATIONS

## Understanding the fail-safe concept

Tapeswitch sensing bumpers often provide the first-line of protection for personnel and equipment. They are highly sensitive and feature press-at-any-point actuation. Properly installed and connected, they continuously monitor contact. However, to properly function as safety devices, bumpers must be installed with a fail-safe monitoring circuit as shown below or with an equivalent fail-safe methodology. Tapeswitch Offers Controllers that Employ the fail-safe Concept.

### Understanding and Implementing the 4 conductor Fail-Safe Principle of Safety

The fail-safe concept monitors the sensor status at all times. In the event of a failure, the fail-safe concept will simulate a protected position. The “protected” position is when the sensor is activated (closed) and the “normal” or “run” position is when the sensor is not activated (open).

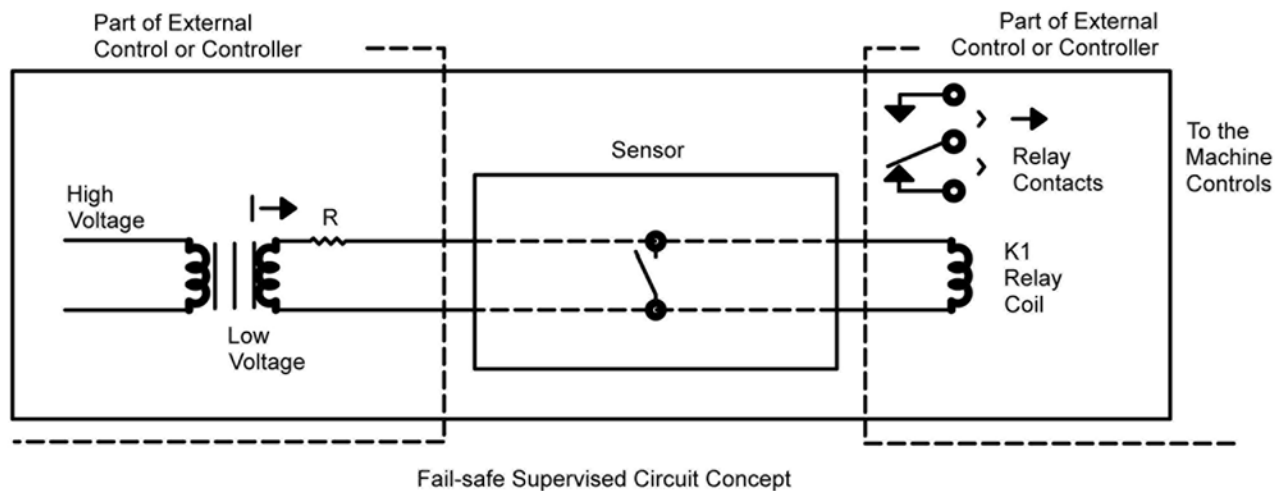

- Normal Conditions – constant current flow (I) holding relay coil (K1) energized
- Loss of Power – no current flow (I) and relay coil (K1) is de-energized
- Actuation of Sensor – relay coil (K1) is shorted and de-energized
- Failure of Sensor in the closed position – relay coil (K1) is shorted and de-energized
- Failure of Sensor in the open position – (broken wire, severed switch or conductor) leaves no path for current flow (I) and relay coil (K1) is de-energized
- Resistor R – limits current flow through the sensor when actuated

### Fail-safe (4 conductor)

Fail-safe is a shorthand term used to mean “fail to a safe condition”. In machinery with known hazards, the system is fail-safe when any failure leaves the machinery in a safe condition. The 4 conductor fail-safe concept is illustrated in the figure above. A small current is constantly flowing through the sensor at all times, holding the relay coil energized at all times. The machine controls, interrupt, or stop circuitry is connected to the contacts of this relay. If the sensor is actuated, the relay coil will be shorted, causing the relay to de-energize. A resistor in series provides current limiting from overdrawing the power supply and limits the current through the sensor in the actuated position. If the sensor fails in the closed position the relay will be shorted and cannot be energized until the failure is corrected. If the sensor fails in the open position, the current path for the relay coil no longer exists and the relay coil cannot be energized until the current path is restored and the failure corrected.

In addition to the safety aspects achieved with fail-safe, it also provides:

- Isolation of the machine controls and sensor(s)
- Isolation of high amperage and high voltage machine switching from the low voltage sensors
- Conversion of a normally open switch to required normally closed machine controls

While every effort has been made to ensure the accuracy of the information provided, no liability can be taken for any errors or omission. Tapeswitch Corporation reserves the right to alter specifications and introduce improvements without prior notice.

# SE-45 & SE-75 SENSING BUMPERS

## For general purpose, heavy duty applications

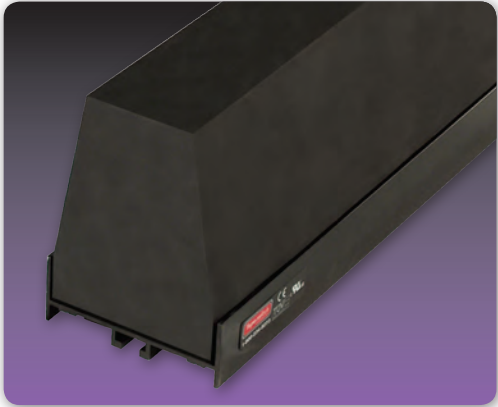

**SE-45 & SE-75 Sensing Bumpers** are designed for general-purpose, heavy-duty applications. When deformed by contact or impact, they provide a signal in the form of an electrical contact closure. At the same time, the large, compliant surface and substantial overtravel cushioning helps protect personnel and equipment from injury or damage. Operating force is 20 pounds nominal.

These bumpers feature easy bolt-on mounting with adjustable bolt locations. The exterior housings are EPDM rubber, which is resistant to water, oil, hydraulic fluids, and coolants. The internal switching elements are rated for millions of operations at any point. All SE Series bumpers are supplied with 4 conductor, fail-safe wiring and are compatible with Tapeswitch Safety Interface Controllers.

### Features & Benefits

- Large sensing area maximizes the detection zone
- Less than 10% compliance before activation and 60% overtravel cushioning after activation
- Straight configurations available and corner configurations for the SE-75
- Fail-safe wiring is standard
- Compliance before activation: 1/2 inch max
- Overtravel after activation: 3 inches
- Available lengths: 6 inch to 12 feet
- SE-75 corner bumper available

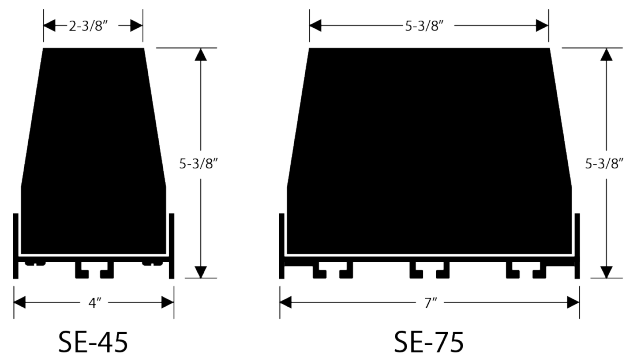

### Applications

- Collision detection on AGVs, mobile work platforms, and material handling equipment
- Obstruction detection on large moving doors, mobile work stations, and telescoping conveyors
- Protection of stationary devices in proximity to moving equipment

### Specifications

Exterior Housing	Fiber-reinforced black EPDM rubber
Actuation Force	20 lbs (89 N) nominal @ 68°F
Recommended Voltage & Current	24 VAC or VDC at 1.0 amps max.
Environment	-10 to 155°F (-23 to 68°C)
Chemical Resistance	Excellent to water, mild acids and bases, many solvents
Mounting	Black anodized aluminum channel with bolt slots

While every effort has been made to ensure the accuracy of the information provided, no liability can be taken for any errors or omission. Tapeswitch Corporation reserves the right to alter specifications and introduce improvements without prior notice.



# HERCULES RUGGEDIZED SENSING BUMPER

## For hostile environments off-limits to conventional bumpers

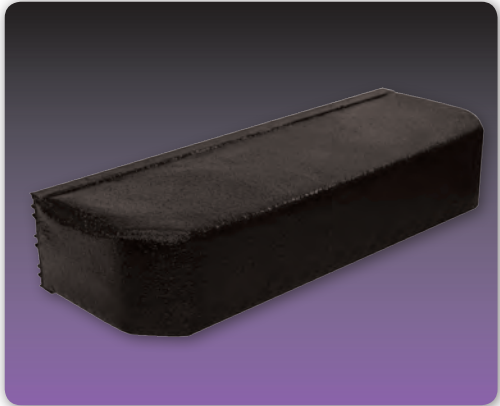

The **Hercules Ruggedized Sensing Bumper** is designed to operate in hostile environments that are off-limits to conventional bumpers. Originally designed for marine spray environments, it is encapsulated in a rugged polyurethane shell that meets MIL-STD-810E salt fog requirements and is resistant to many common industrial chemicals and fluids.

The **Hercules bumper** is abrasion-resistant, impact-resistant, and crush-resistant. It is suitable for use on AGVs, mobile platforms, traveling conveyors, and other moving equipment.

### Features & Benefits

- Encapsulated in a rugged polyurethane shell
- Water resistant - meets MIL-STD-810E salt fog
- Suitable for outdoor and marine applications
- Crush, impact, and abrasion resistant
- Available in lengths up to 12 feet
- Fail-safe wiring is standard

Hercules bumpers are available in 4 inch and 7 inch widths, up to 18 inches high, and with a maximum length of 12 feet. Special capabilities include multiple sensing zones and corner bumper designs.

### Applications - Detect impact or collisions on:

- Automatic guided vehicles
- Moving work platforms
- Large moving doors
- Mobile conveyors
- Telescoping equipment
- Passenger loaders

### Specifications

Exterior Housing	Polyurethane
Actuation Force	20 to 30 lbs (89 to 133 N) nominal, depending on model
Compliance before actuation	1 in. (25 mm) typical
Recommended Voltage & Current	24 VAC or VDC at 1.0amps max.
Environment	-10 to 155°F (-23 to 68°C)
	Water resistant per MIL-STD-810E salt fog
Color	Black is standard, other colors available on request

While every effort has been made to ensure the accuracy of the information provided, no liability can be taken for any errors or omission. Tapeswitch Corporation reserves the right to alter specifications and introduce improvements without prior notice.

# VBL-SERIES HIGH-IMPACT SENSING BUMPERS

## For applications subject to repeated high impacts

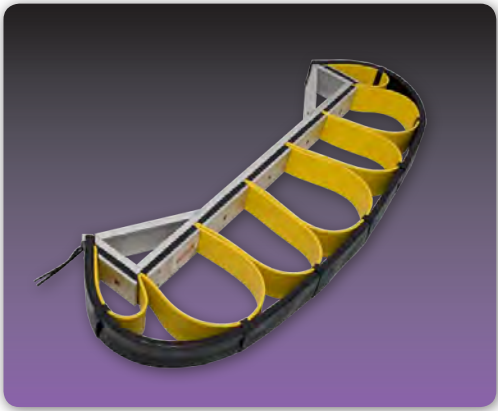

The **VBL-Series High-Impact Sensing Bumpers** are designed to survive repeated crushing impacts that would destroy conventional bumpers. When deformed by contact or impact, they provide a signal in the form of an electrical contact closure. They are suitable for use on AGVs, mobile platforms, traveling conveyors, and other moving equipment or machinery. Sensitivity is uniform over the entire bumper surface, including any curved areas.

**VBL-Series Bumpers** are available in lengths from 4 inches to 16 feet and in linear, winged, or corner configurations. The VBL-125 is 1.25 inches wide at the base and the VBL-250 is 2.5 inches wide. Yellow is standard, but other colors can be provided. An optional polyurethane cover is available for added durability. The bumper contact area has a rugged polyurethane cover for added durability.

### Features & Benefits

- Survives repeated severe impacts
- Requires no guide wires and no adjustments
- Simple mounting options for easy installation
- Standard and winged versions
- Available in lengths up to 16 feet
- Fail-safe wiring is standard

### Applications

- Automatic guided vehicle bumpers
- Protective edging on moving work platforms
- Horizontal or vertical sensing on large moving doors
- Contact detection on large and small mobile conveyors
- Collision detection on telescoping devices
- Position sensing on passenger loaders

### Specifications

Exterior Housing	Polyurethane
Actuation Force	4 lbs. (18N) nominal @ 68°F
Dimensions	Length: 4 in. to 16 ft. long Width: 1.25 in. (VB-125) or 2.50 in. (VB-250) Height: 8 in. max
Recommended Voltage & Current	24 VAC or VDC at 1.0 amps max.
Environment	50 to 120°F (10 to 49°C) Waterproof per MIL-STD-810E salt fog
Color	Contact area black, support loops yellow

While every effort has been made to ensure the accuracy of the information provided, no liability can be taken for any errors or omission. Tapeswitch Corporation reserves the right to alter specifications and introduce improvements without prior notice.



# SE-C CUSTOM SENSING BUMPERS

## Various sensitivities, profiles, colors, and lengths

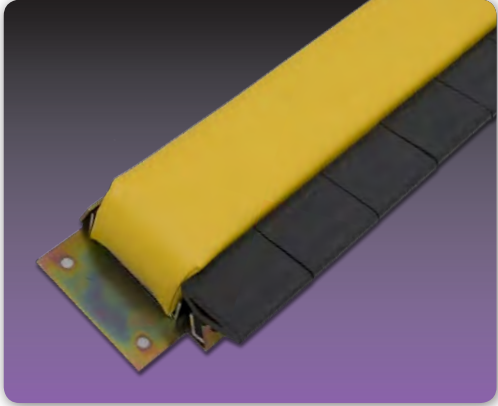

**SE-C Custom Sensing Bumpers** are designed to fit specific application needs. When deformed by contact or impact, they provide a signal in the form of an electrical contact closure. They have a large, compliant surface that helps protect personnel and equipment from injury or damage. The nylon-reinforced exterior housings are resistant to water, oil, hydraulic fluids, and coolants. Mounting options include studs and threaded holes.

These bumpers can be made in various sensitivities, profiles, colors, and lengths. Special options include multiple-surface detection, multiple zones, and high sensitivity. Extra-large sizes and corner designs are also available. All SE-C Series bumpers are supplied with 4 conductor, fail-safe wiring and are compatible with Tapeswitch Safety Interface Controllers.

### Features & Benefits

- Straight and corner configurations available
- Standard 4 conductor fail-safe wiring
- Options for multi-surface detection and multiple zones
- Large sensing area to maximize the collision-sensing zone
- Available in extra-large sizes and with extra overtravel
- Custom mounting options, including quick disconnects

### Applications

- Collision detection on AGVs, mobile work platforms, and material handling vehicles
- Obstruction detection on large moving doors, mobile work stations, and telescoping conveyors
- Protection of stationary devices in proximity to moving equipment
- General hazard protection requiring overtravel cushioning

### Specifications

Exterior Housing	Dynalon
Actuation Force	Per customer specifications
Recommended Voltage & Current	24 VAC or VDC at 1.0 amps max.
Operating Temperature	32 to 122°F (0 to 50°C)
Color	Black (heavy weight) or yellow (medium weight) Other colors available on request

While every effort has been made to ensure the accuracy of the information provided, no liability can be taken for any errors or omission. Tapeswitch Corporation reserves the right to alter specifications and introduce improvements without prior notice.

# SAFETY INTERFACE MODULES FOR BUMPERS

Tapeswitch manufactures Safety Interface Modules (SIM) that are compatible with all of the **Sensing Bumper** products shown in this catalog. These devices provide an interface between the low-voltage **Sensing Bumper Switches** and the machine or device being controlled. Be certain to select the appropriate controller for the application. For detailed specifications, see our catalog for Interface Controllers, or visit [www.tapeswitch.com](http://www.tapeswitch.com).

Safety applications require the use of both a fail-safe **sensing bumper** and a fail-safe rated Interface Controller. For non-safety applications, any mix of fail-safe and non fail-safe devices may be used.

## PCU/1 Control Unit - Programmable control unit.

This controller allows for the connection, control, and streamlining of multiple safety devices with programmable logic control functions, such as safety sensors and signals, light curtains, safety photocells, e-stops, safety mats, sensing edges, sensing bumpers, two-hand controls, magnetic or mechanical switches. Check website for category and SIL safety level. The easy to use software allows for multiple functions and logic controls and has a configurable memory a list of input and output objects for a user friendly interface. It is USB capable for connection to the most common industrial Fieldbus systems for diagnostics and data communication. The stand alone controller has 8 input, 2 OSSD pairs, 4 test outputs, 2 digital signaling outputs, 2 inputs for restart, and 24 connectors, plus several different expansion units for additional inputs, outputs, and signaling and connectors plus additional safety relays.



## PSSR/2 Control Unit - Fail-safe controller for end of the line resistor products.

The PSSR/2 safety interface controller is designed for 1 or 2 input sensors and offers Category 3, SIL2, PLd safety level performance and meets EN13849-1:2008. It is self monitoring and offers integrity monitoring of any 6.8 to 8.2 k ohm end of the line resistor product, such as switches, mats, and edges that incorporate a 6.8 to 8.2 k ohm resistor, making a complete safety system. It has forced guided relays and 2 normally open (safety) and 1 normally closed (monitor) contacts. It has a manual or auto reset function. It has a maximum sensor length of 330 feet. It is 22.5 mm din rail mountable.



## PRSU Control Units - Our most compact fail-safe module.

Can be used for high-risk automation and machine control applications. Compatible with all Tapeswitch sensing products, including switches, edges, bumpers, and mats. This controller exceeds the requirements of category 3 of EN 954-1, certified to EN ISO 13849-1 and meets or exceeds the safety content of the applicable OSHA, ANSI, and RIA standards. Available in a DIN rail-mounted package, with two power options. PRSU/4 operates on 24 VDC or VAC supply, PRSU/5 operates on 115 VAC supply. Both models feature manual and automatic reset capability.



## MZ-Series MultiZone Controller - Custom designs for custom controls.

Acts as an interface between various Tapeswitch sensing devices and a machine or process control. Designed to monitor up to 6 zones and provides power to all connected B-series Light Curtains emitters and receivers and monitors the output signals. Also interfaces with a variety of pressure sensitive, normally-open switches made by Tapeswitch, including ribbon switches, safety mats, sensing edges and bumpers.



## PSSU Control Units - 6 fail-safe models in 3 package styles.

For automation and machine control applications. These controllers exceed the requirements of category 3 of EN 954-1 and meet or exceed the safety content of the applicable OSHA, ANSI, and RIA standards. Available in wall-mounted and DIN rail-mounted versions with voltage options of 110/240 VAC or 24 VDC operation. Auto or manual reset, depending on model.



While every effort has been made to ensure the accuracy of the information provided, no liability can be taken for any errors or omission. Tapeswitch Corporation reserves the right to alter specifications and introduce improvements without prior notice.







# Some of the industries we serve.

Industrial Plant Maintenance Stamping Lock out **Area Guarding**

Metalworking **Plant Safety Military** Material Handling Signaling

Fabricating Manufacturing **Robotics** Process Control **OEM's**

**Packaging** Aerospace Public Safety Gaming **Sensing** Medical

**Machine Guarding** Monitoring Entertainment Access Control

Emergency Response **Transportation** Amusement Parks

Motion Sensing Monitoring Counting **Machine Control** Security



**800-234-8273**

Tapeswitch Corporation

100 Schmitt Boulevard, Farmingdale, NY 11735

[www.tapeswitch.com](http://www.tapeswitch.com) • [sales@tapeswitch.com](mailto:sales@tapeswitch.com)

Tel: 631.630.0442 • Fax: 631.630.0454

